

RS8-RS10/RD10

- 6 Pin SIL Package
- Wide 2:1 Input Range
- 1500VDC Isolation
- Continuous Short Circuit Protection
- no minimum Load required
- Efficiency up to 81%
- Operating Temperature Range
-40° ~ +85°C
- Non Conductive Black Plastic Case

RoHS



OUTPUT SPECIFICATION	ENVIRONMENTAL SPECIFICATION
Voltage accuracy: ±2%	Operating Temperature range: -40°C ~+85°C (see Derating Curve)
Maximum Output Current: See table	Maximum Case Temperature: 105°C
Line regulation: ± 0.2% max.	Storage Temperature : -55°C ~+125°C
LOAD REGULATION: 0% - 100% (Single/Dual Outp.): ±1% max./±2% max. 5% - 100% (Dual Outp.): ±1% max.	Cooling : Nature Convection
Cross Regulation (Dual Output): ± 5%	PHYSICAL SPECIFICATIONS:
Short Circuit Protection : Continuous (Automatic Recovery)	Case Material: Non-conductive Black Plastic (UL94V-0 rated)
Ripple noise (20Mhz bandwidth): 50mV pk-pk max.	PIN Material SIP Case: C5191T-H Solder coated
Temperature coefficient: ±0.02% °C	Potting Material: Epoxy (UL94V-0 rated)
Capacitor load: See table	Weight Case- Sip: 3.0g,
Transient Recovery Time: 500us, typ.	Dimmension SIP: 0.67 x 0.30 x 0.43"
Transient Response: (Deviation) ±3% max.	ABSOLUTE MAXIMUM RATINGS (1)
INPUT SPECIFICATIONS	Input Surge Voltage (100ms)/
Voltage Range: See table	5 V Models: 15VDC max.
Max. Input Current: See table	12V Models: 25VDC max.
No-Load/Full-Load Input Current: See table	24V Models: 50VDC max.
Input Filter: Capacitors	48V Models: 100VDC max.
Input Reflected Ripple Current : 35mA pk-pk	Soldering Temperature: 260°C max. (2)
GENERAL SPECIFICATIONS	EMC SPECIFICATIONS
Efficiency: See table	Radiated-/Conducted Emissions: EN55022 Class A
I/O Isolation Voltage (60sec): 1500VDC	ESD: IEC 61000-4-2 Perf.Criteria A
I/O Isolation Capacitance: 70pF typ.	RS: IEC 61000-4-3 Perf.Criteria A
I/O Isolation Resistance: 1000M Ohm, min	EFT: IEC 61000-4-4 Perf.Criteria A
Switching Frequency: 150 - 550kHz	SURGE: IEC 61000-4-5 Perf.Criteria A
Humidity: 95% rel H	CS: IEC 61000-4-6 Perf.Criteria A
Reliability Calculated MTBF : > 2.8Mhrs (MIL-HDBK-217 f)	PFMF IEC 61000-4-8 Perf.Criteria A
Safety Standard: (designed to meet): IEC EN 60950-1	

- 1) These are stress ratings. Exposure of devices to any of these conditions may adversely affect long-term reliability.
- 2) (1.5mm from case 10sec Max.)
- 3) All specifications typical at TA= 25°C, nominal input voltage and full load unless otherwise specified.
- 4) The information and specification contained in this data sheet are believed to be correct at time of publication. However RSG accepts no responsibility for consequences arising from printing errors or inaccuracies. Specifications are subject to change without notice.

NUMBER STRUCTURE

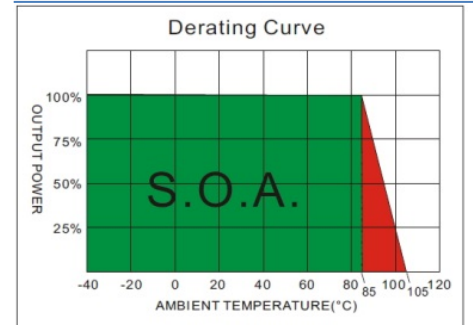
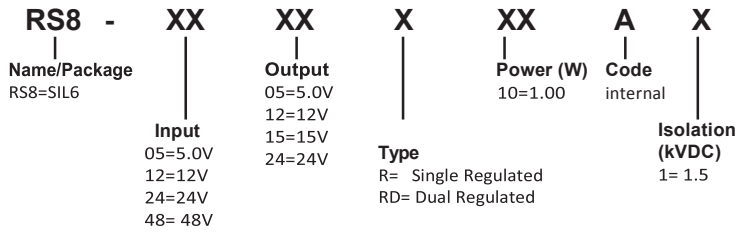

MODEL SELECTION GUIDE

MODEL NUMBER	INPUT Voltage Range (Vdc)	INPUT Current		OUTPUT Voltage (Vdc)	OUTPUT Current		EFFICIENCY @FL (%)	Capacitive Load (uF)
		No-Load (mA)	Full Load (mA)		Min. load (mA)	Full load (mA)		
RS8-0505R10A1	4.5-9	35	263	5	0	200	76	1680
RS8-0512R10A1	4.5-9	35	253	12	0	83	79	820
RS8-0515R10A1	4.5-9	35	250	15	0	67	80	680
RS8-0524R10A1	4.5-9	35	250	24	0	42	80	470
RS8-1205R10A1	9-18	20	107	5	0	200	78	1680
RS8-1212R10A1	9-18	20	105	12	0	83	80	820
RS8-1215R10A1	9-18	20	103	15	0	67	81	680
RS8-1224R10A1	9-18	20	105	24	0	42	80	470
RS8-2405R10A1	18-36	10	54	5	0	200	78	1680
RS8-2412R10A1	18-36	10	52	12	0	83	80	820
RS8-2415R10A1	18-36	10	52	15	0	67	80	680
RS8-2424R10A1	18-36	10	52	24	0	42	81	470
RS8-4805R10A1	36-75	7	28	5	0	200	76	1680
RS8-4812R10A1	36-75	7	27	12	0	83	78	820
RS8-4815R10A1	36-75	7	27	15	0	67	78	680
RS8-4824R10A1	36-75	7	27	24	0	42	77	470
RS8-0512RD10A1	4.5-9	35	259	±12	0	±42	77	±470
RS8-0515RD10A1	4.5-9	35	254	±15	0	±33	79	±330
RS8-1212RD10A1	9-18	20	106	±12	0	±42	79	±470
RS8-1215RD10A1	9-18	20	105	±15	0	±33	80	±330
RS8-2412RD10A1	18-36	10	52	±12	0	±42	80	±470
RS8-2415RD10A1	18-36	10	53	±15	0	±33	79	±330
RS8-4812RD10A1	36-75	7	27	±12	0	±42	77	±470
RS8-4815RD10A1	36-75	7	27	±15	0	±33	77	±330

1. One load is 25% to 100% load, the other load is 100% load, the output voltage variable rate is within ±5%.
2. Ripple/Noise measured with a 1uF ceramic capacitor.
3. Tested by minimal Vin and constant resistive load.
4. Tested by normal Vin and 25% load step change (75%-50%-25% of Io).
5. Measured Input reflected ripple current with a simulated source inductance of 12uH.
6. Exceeding the absolute ratings of the unit could cause damage. It is not allowed for continuous operating.
7. Input filter components are be required to help meet conducted emission class A, which application refer to The EMI Filter of Design & feature configuration.
8. An external filter capacitor is required if the module has to meet IEC61000-4-4 and IEC61000-4-5.
The filter capacitor RSG suggest: 5Vin models : Nippon - chemi - con KY series, 330uF/100V.
Other models : Nippon - chemi - con KY series, 220uF/100V.

Input Reflected Ripple Current Test Step

Input reflected ripple current is measured through a source inductor L_{in} (12 μ H) and a source capacitor C_{in} (47 μ F, ESR<1.0 Ω at 100KHz) at nominal input and full load.

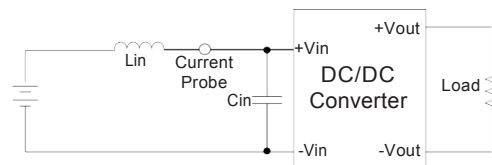

Output Ripple & Noise Measurement Test

Use a capacitor C_{out} (1.0 μ F) measurement. The Scope measurement bandwidth is 20MHz.

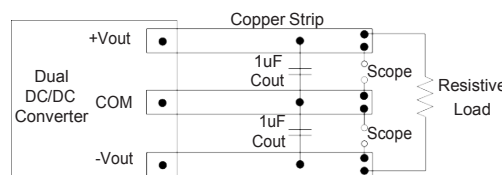
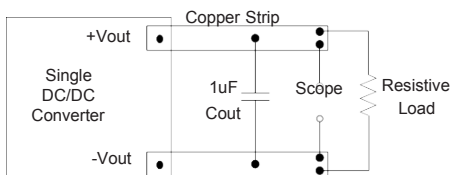

EMI Filter

Input filter components (C_1, C_2, L) are used to help meet conducted emissions requirement for the module. These components should be mounted as close as possible to the module; and all leads should be minimized to decrease radiated noise.

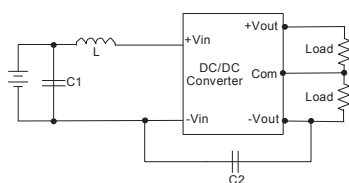
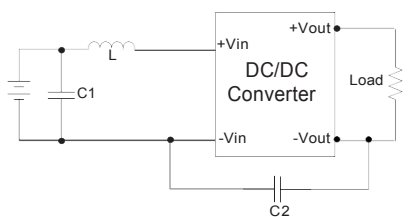

	C1	C2	L
RS8-05XXR/RD10A1	MLCC 4,7 μ F/50V	MLCC 220 μ F/3KV	4.7 μ H
RS8-12XXR/RD10A1	MLCC 4,7 μ F/50V	MLCC 220 μ F/3KV	4.7 μ H
RS8-24XXR/RD10A1	MLCC 4,7 μ F/50V	MLCC 220 μ F/3KV	18 μ H
RS8-48XXR/RD10A1	MLCC 4,7 μ F/100V	MLCC 220 μ F/3KV	18 μ H

RS8-RS10/RD10

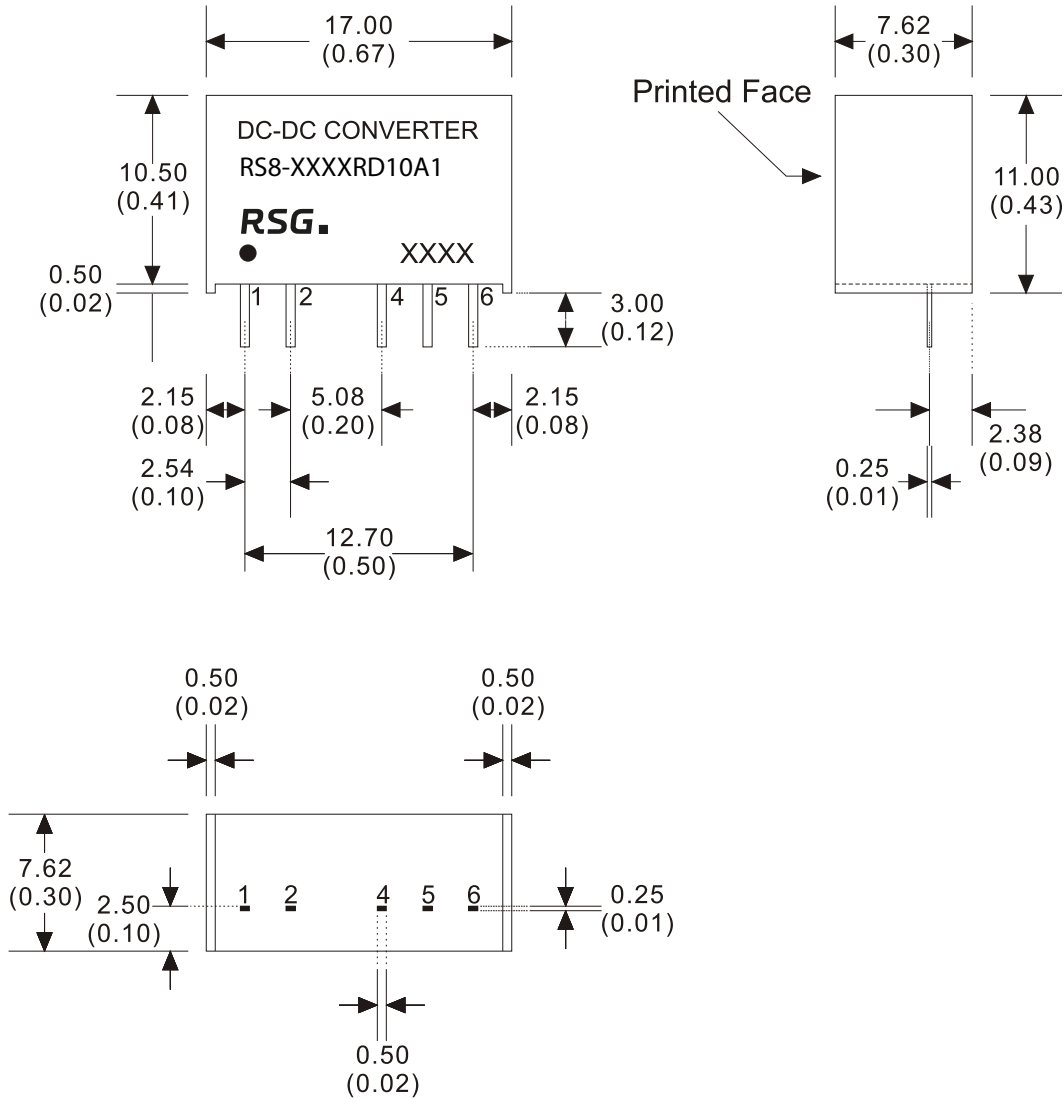

PIN CONNECTIONS		
PIN NUMBER	SINGLE	DUAL
1	-V Input	-V Input
2	+V Input	+V Input
4	+V Output	+V Output
5	N.P.	Common
6	-V Output	-V Output

6 Pin SIL Package

- Notes : All dimensions are typical in millimeters (inches).
1. Pin diameter: 0.5±0.05 (0.02±0.002)
 2. Pin pitch and length tolerance: ±0.35 (±0.014)
 3. Pin to case tolerance: ±0.5 (±0.02)
 4. Case Tolerance: ±0.5 (±0.02)
 5. Stand-off tolerance: ±0.1 (±0.004)

The models listed here are just standard type. If you need a product with special specification or you have questions regarding packing standards (Tube oder Tape/Reel) as well as application support, please contact our specialists: sales@rsg-electronic.de or +49 69-984047-41/-28